

Bridge Rectifiers

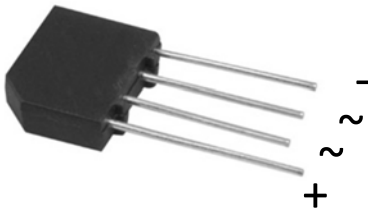

Features

- UL recognition, file #E230084
- Glass passivated chip junction
- Ideal for printed circuit boards
- High surge current capability
- Solder dip 275 °C max. 7 s, per JESD 22-B106

Typical Applications

General purpose use in AC/DC bridge full wave rectification for switching power supply, home appliances, office equipment, industrial automation applications.

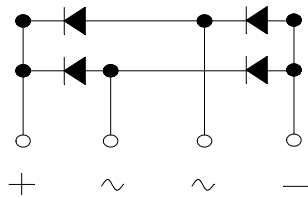

Mechanical Data

- **Package:** KBP
Molding compound meets UL 94 V-0 flammability rating, RoHS-compliant
- **Terminals:** Tin plated leads, solderable per J-STD-002 and JESD22-B102
- **Polarity:** As marked on body

■ Maximum Ratings (T_a=25°C Unless otherwise specified)

PARAMETER	SYMBOL	UNIT	KBP2005	KBP201	KBP202	KBP204	KBP206	KBP208	KBP210
Device marking code			KBP2005	KBP201	KBP202	KBP204	KBP206	KBP208	KBP210
Maximum Repetitive Peak Reverse Voltage	VRRM	V	50	100	200	400	600	800	1000
Maximum RMS Voltage	VRMS	V	35	70	140	280	420	560	700
Maximum DC blocking Voltage	VDC	V	50	100	200	400	600	800	1000
Average rectified output current @60Hz sine wave, R-load, T _c =110°C	I _O	A	2						
Forward Surge Current (Non-repetitive) @8.3ms Half-sine wave, 1 cycle, T _j =25°C	I _{FSM}	A	45						
Forward Surge Current (Non-repetitive) @1ms, square wave, 1 cycle, T _j =25°C			90						
Current squared time @1ms≤t≤8.3ms T _j =25°C, Rating of per diode	I ² t	A ² s	8.4						
Storage temperature	T _{stg}	°C	-55 ~ +150						
Junction temperature	T _j	°C	-55 ~ +150						

■ Electrical Characteristics (T_a=25°C Unless otherwise specified)

PARAMETER	SYMBOL	UNIT	TEST CONDITIONS	KBP2005	KBP201	KBP202	KBP204	KBP206	KBP208	KBP210
Maximum instantaneous forward voltage drop per diode	V _F	V	I _{FM} =1.0A	1.0						
Maximum DC reverse current at rated DC blocking voltage per diode	I _R	μA	T _j =25°C	5						
			T _j =125°C	100						
Typical junction capacitance	C _j	pF	Measured at 1MHz and Applied Reverse Voltage of 4.0 V.D.C	13						



KBP2005 THRU KBP210

■ Thermal Characteristics (T_a=25°C Unless otherwise specified)

PARAMETER		SYMBOL	UNIT	KBP2005	KBP201	KBP202	KBP204	KBP206	KBP208	KBP210
Thermal Resistance	Between junction and ambient	R _{θJ-A}	°C/W	30						
	Between junction and lead	R _{θJ-L}		15						
	Between junction and case	R _{θJ-C}		10						

■ Ordering Information (Example)

PREFERRED P/N	PACKAGE CODE	UNIT WEIGHT (g)	MINIMUM PACKAGE(pcs)	INNER BOX QUANTITY(pcs)	OUTER CARTON QUANTITY(pcs)	DELIVERY MODE
KBP2005 ~ KBP210	A1	Approximate 1.75	500	500	5000	Paper Box

■ Characteristics (Typical)

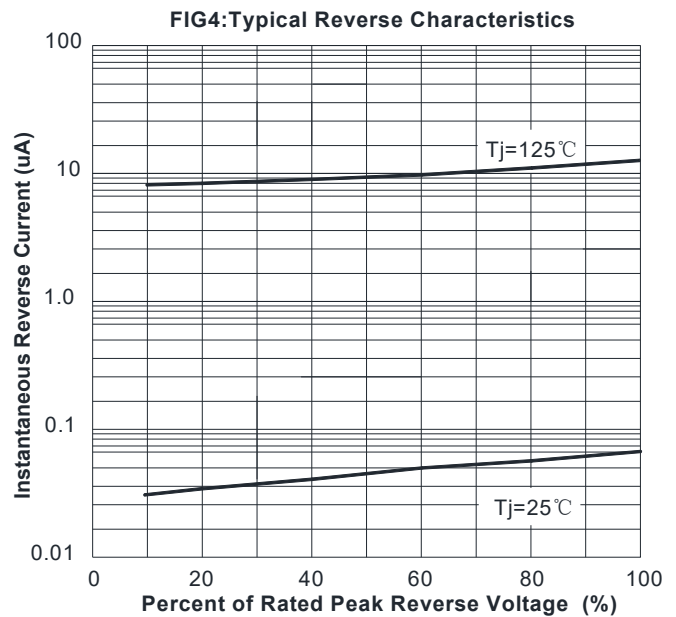
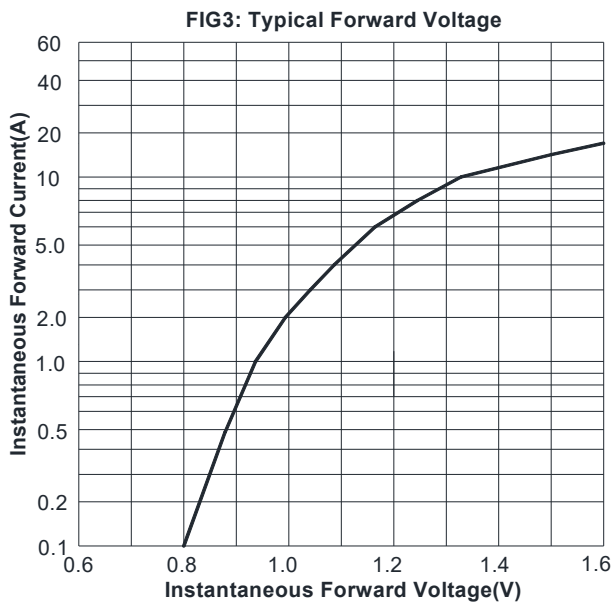
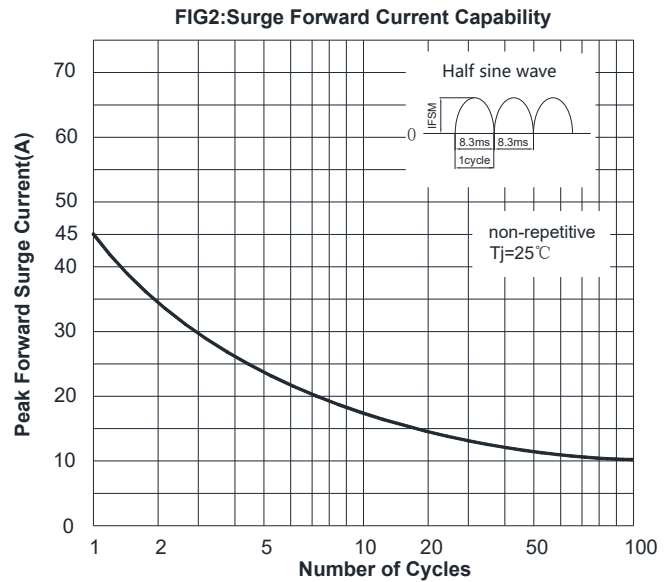
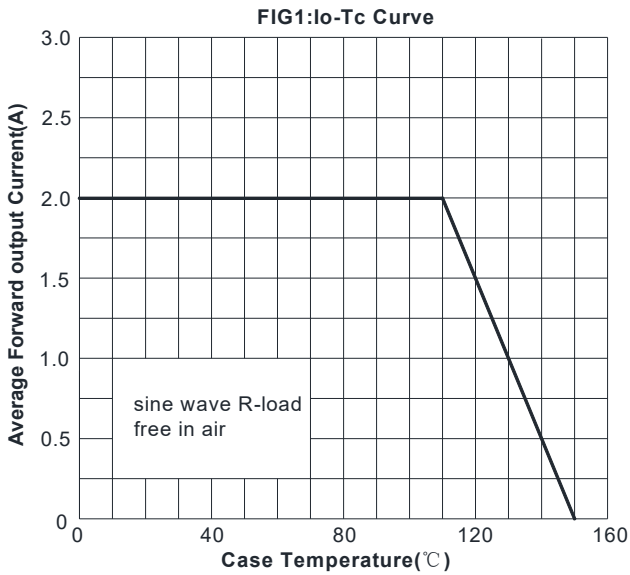



KBP2005 THRU KBP210

■ Outline Dimensions

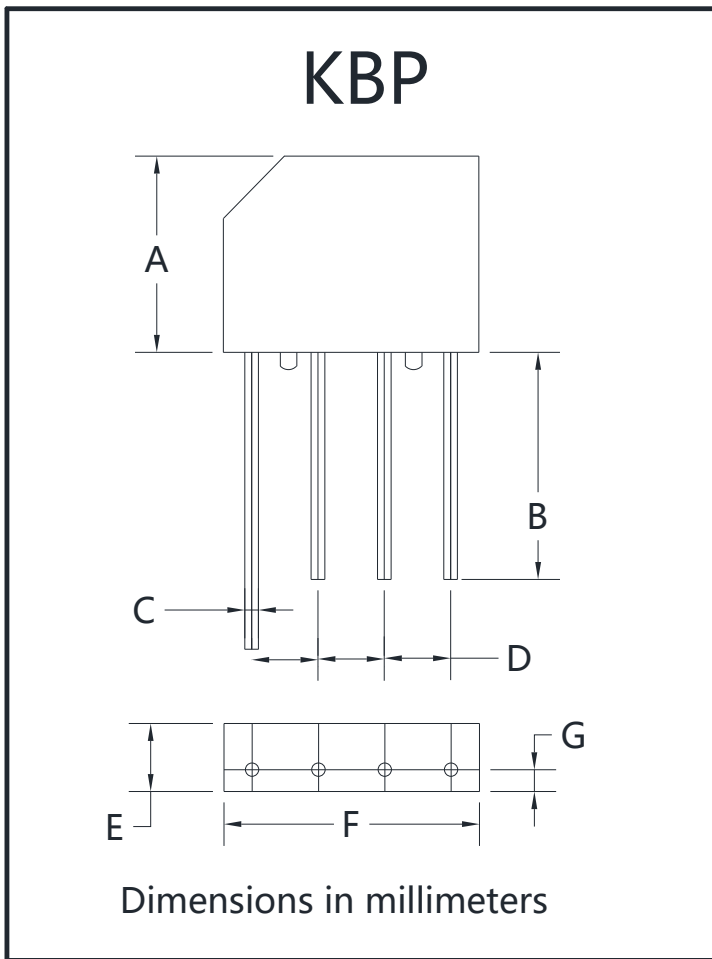

KBP		
Dim	Min	Max
A	11.0	11.6
B	12.7	/
C	0.7	0.9
D	3.6	4.1
E	3.7	3.95
F	14.4	15.0
G	1.10	1.27



KBP2005 THRU KBP210

Disclaimer

The information presented in this document is for reference only. Yangzhou Yangjie Electronic Technology Co., Ltd. reserves the right to make changes without notice for the specification of the products displayed herein to improve reliability, function or design or otherwise.

The product listed herein is designed to be used with ordinary electronic equipment or devices, and not designed to be used with equipment or devices which require high level of reliability and the malfunction of which would directly endanger human life (such as medical instruments, transportation equipment, aerospace machinery, nuclear-reactor controllers, fuel controllers and other safety devices), Yangjie or anyone on its behalf, assumes no responsibility or liability for any damages resulting from such improper use of sale.

This publication supersedes & replaces all information previously supplied. For additional information, please visit our website [http:// www.21yangjie.com](http://www.21yangjie.com) , or consult your nearest Yangjie's sales office for further assistance.